

SCHEDA DI REGOLAZIONE KOMBI HYBRID K1060



REGOLAZIONE VERTICALE



Allentare le viti di blocco **A** su tutte le cerniere presenti nel pannello



Posizionare manualmente il pannello **P** fino all'altezza corretta



Serrare le viti di blocco **A** su tutte le cerniere (max 4 Nm)

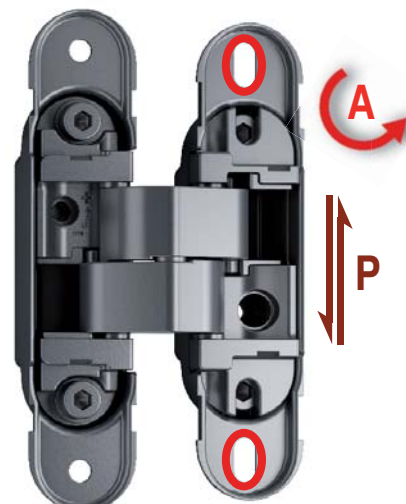

REGOLAZIONE ORIZZONTALE



Ruotare le viti **B**

Nota: compiere la stessa rotazione su entrambe le viti

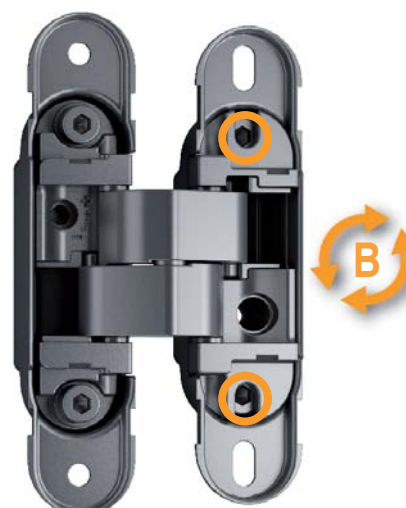

REGOLAZIONE DI PROFONDITÀ



Allentare le viti di blocco **C** su tutte le cerniere presenti nel pannello



Ruotare l'eccentrico **D**



Serrare le viti di blocco **C** su tutte le cerniere (max 4 Nm)

