

# SYSTEM 1760/80/120 ABS

Istruzioni di Montaggio - Instrucciones de montaje - Montageanleitung - Assembling Instructions - Instructions de Montage - Montageanleitung - Инструкции по монтажу

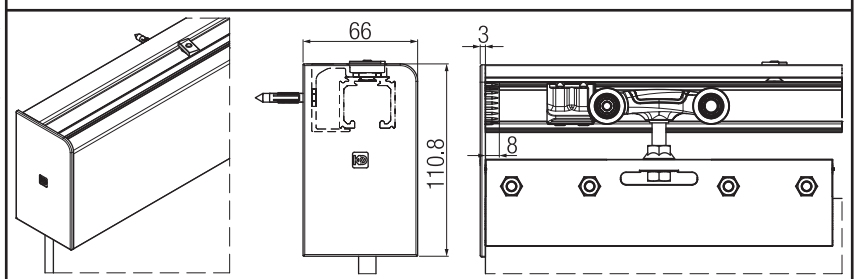
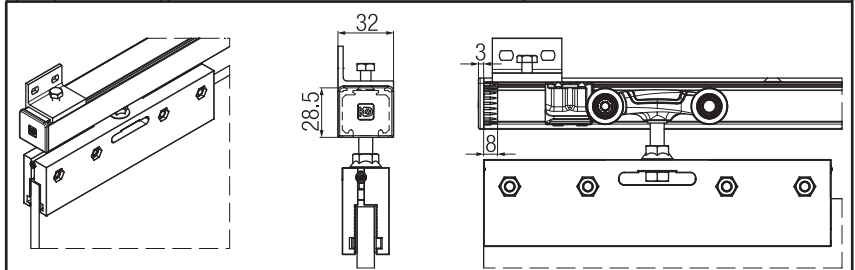
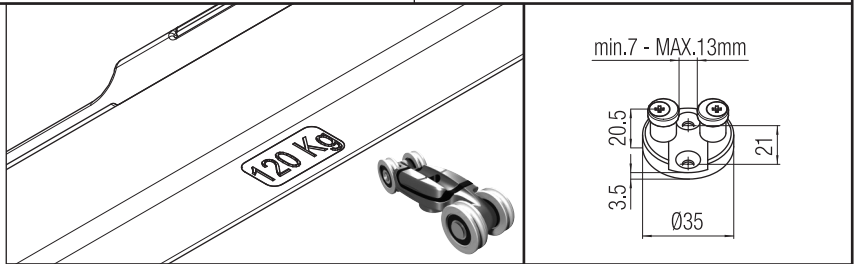
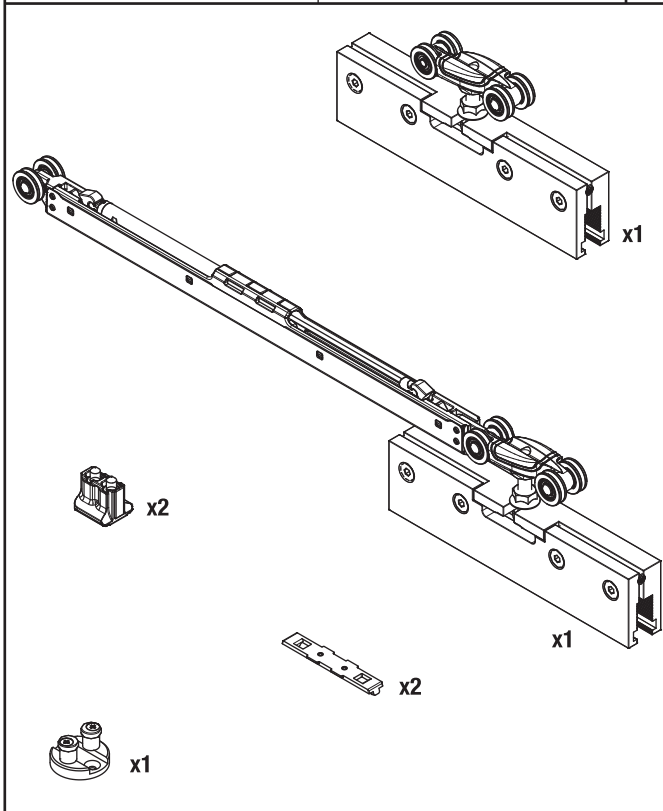
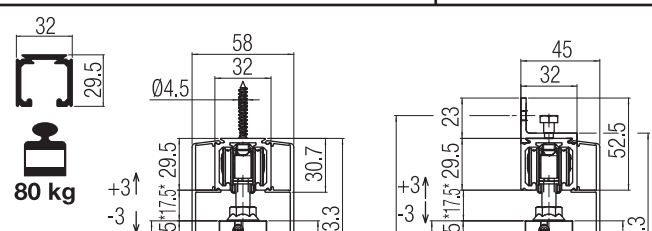
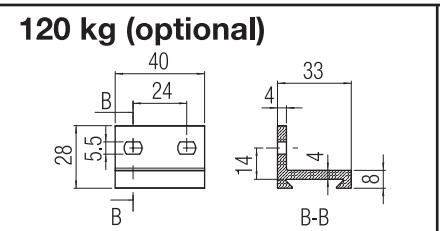
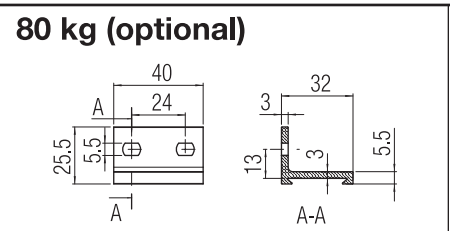
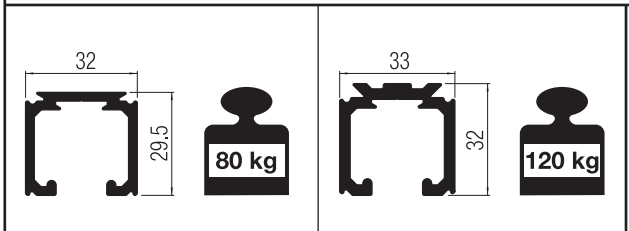

Lpv= Larghezza pannello Hpv= Altezza pannello Spv= Spessore pannello Hp= Altezza pannello + pinza vetro Hup= Altezza utile di passaggio Ht= Altezza fissaggio binario	Lpv= Anchura panel Hpv= Altura panel Spv= Espesor panel Hp= Altura panel + mordaza vidrio Hup= Altura de paso Ht= Altura fijación guía	Lpv= Türblattbreite Hpv= Türblatthöhe Spv= Türblattdicke Hp= Türblatthöhe + Glasfierzangen Hup= Bodenfreiheit Ht= Höhe der Befestigungs Schiene	Lpv= Door leaf width Hpv= Door leaf height Spv= Panel thickness Hp= Door leaf height + glass retainer clamp Hup= Free passage height Ht= Fixing height track	Lpv= Largeur vantail Hpv= Hauteur vantail Spv= Epaisseur vantail Hp= Hauteur vantail + mâchoire verre Hup= Hauteur utile de passage Ht= Hauteur fixations rail	Lpv= Deurbreedte Hpv= Deurhoogte Spv= Panel dikte Hp= Deurhoogte + glasklem Hup= Vrije ruimte hoogte Ht= Hoogte bevestiging rail	Lpv= Ширина панели Hpv= Высота панели Spv= Толщина панели Hp= Высота панели + Держатель для стекла Hup= Полезная высота прохода Ht= Высота фиксации профиля
--	---	--	---	---	---	--

Illustrazioni, fotografie, disegni e dati tecnici, prestazioni, essenze e colori hanno valore puramente indicativo e non sono vincolanti per noi. Deviazioni o scostamenti non potranno costituire ragioni per la non accettazione della merce o essere motivo per reclami. Tutti i modelli possono subire senza preavviso variazioni nelle sezioni, nella struttura e nel disegno.

Abbildungen, Fotos, Zeichnungen und technische Daten, Farben und Farbenszenen die in diesem Katalog angeführt werden sind rein indikativ und für uns unverbindlich, Änderungen und Abweichungen davon werden nicht als Grund für Nichtentgegnahme der Ware oder für Reklamationen akzeptiert. Alle Modelle können unangekündigt Verbesserungen oder leichte Änderungen und den Sektionen und Zeichnungen erfahren.

The illustrations, photos, images and technical data, features and colours of the catalogue are purely indicative and are not binding for us. The deviations cannot create any reasons for not accepting the goods or cause claims. All the models can be altered, improved or slightly modified in their sections, structure or drawing without any previous notification.

Les illustrations, les photographies, les dessins et les données techniques, les prestations, les couleurs reportées sur ce catalogue ont une simple valeur indicative et ne sont pas astreignants pour nous. Des interprétations ou des jugements personnels ne pourront pas constituer une raison pour la non acceptation de la marchandise ou même être un motif de réclamation. Tous les modèles présentés peuvent subir sans préavis une amélioration ou une légère variation dans les sections, dans la structure ou même dans le dessin.

De illustraties, foto's, afbeeldingen en technische gegevens, kenmerken en kleuren van de catalogus zijn louter indicatief en niet bindend voor ons. Afwijkingen kunnen geen reden zijn om de goederen niet te accepteren of claims in te stellen. Alle modellen kunnen zonder voorafgaande kennisgeving worden gewijzigd, verbeterd of licht gewijzigd in hun secties, structuur of tekening.

Иллюстрации, фотографии, рисунки и технические данные в данном справочнике несут рекомендательный характер, которые не могут быть основанием для отказа от товара или стать причиной рекламации. Все артикулы и чертежи могут быть изменены без предварительного согласования с покупателем.

